

DEPTH MICROMETERS

3

4

- Meet DIN863-2
- Graduation: 0.01mm
- Micrometer head accuracy: $\pm 3\mu\text{m}$
- Rod accuracy: $\pm (2+L/75)\mu\text{m}$, L is the measuring range in mm
- Rods with flat end
- Ratchet stop

Code	Range	Rods	L
3241-25	0-25mm	1 pc	101.5mm
3241-50	0-50mm	2 pcs	101.5mm
3241-75	0-75mm	3 pcs	101.5mm
3241-100	0-100mm	4 pcs	101.5mm
3241-150	0-150mm	6 pcs	101.5mm
3241-200	0-200mm	8 pcs	101.5mm
3241-300	0-300mm	12 pcs	101.5mm
3241-B25	0-25mm	1 pc	63mm
3241-B50	0-50mm	2 pcs	63mm
3241-B100	0-100mm	4 pcs	63mm
3241-B150	0-150mm	6 pcs	63mm
3241-B300	0-300mm	12 pcs	63mm



3241-100

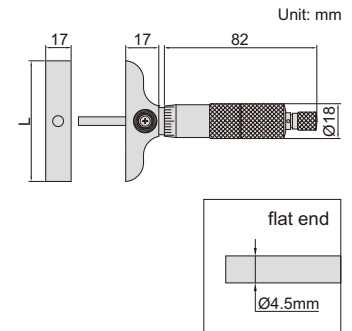
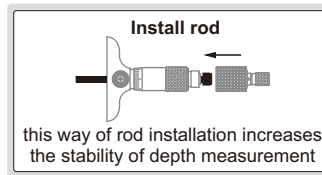

HIGH PRECISION DIGITAL HEIGHT GAGES



power supplied by charge pal

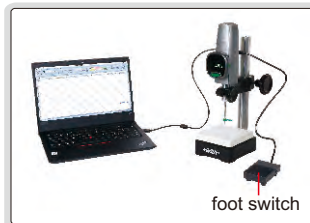

data transmitted to Excel without software; short press the foot switch to transmit data, long press to zero

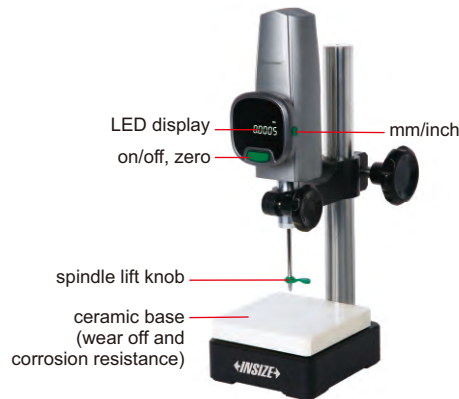

1155-505

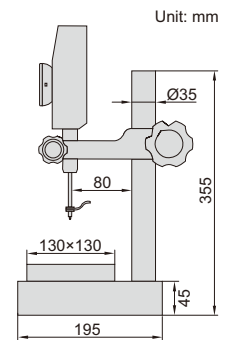

- High stability, high precision, high response speed (5000mm/s)
- High brightness LED display
- Ceramic base flatness: $1\mu\text{m}$

Code	Range	Resolution	Accuracy (20°C)	Measuring force	Output	Power supply
1155-505	0~50mm	0.5 μm /0.00002" (can switch to: 1 μm /0.00005")	1.5 μm	0.8~1.2N	USB	5V/1A (adapter or charge pal)
1155-510	0~50mm	0.1 μm /0.000005" (can switch to: 1 μm /0.00005")	1 μm	0.8~1.2N	USB	5V/1A (adapter or charge pal)

OPTIONAL ACCESSORY

Contact point	code 6282
Charge pal	1155-5-POB
Data output cables (including foot switch)	1155-5-FOS

STANDARD DELIVERY

Main unit	1 pc
-----------	------

DIGITAL HEIGHT GAGES

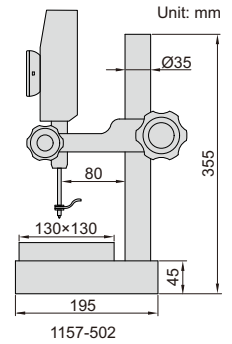
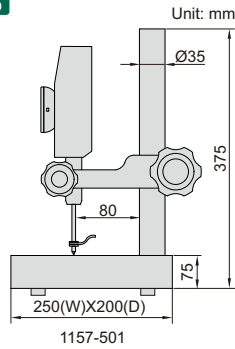

- Buttons: on/off, zero, mm/inch, mix/min/mix-min
- High response speed (5000mm/s)
- High brightness LED display



data transmitted to Excel without software; short press the foot switch to transmit data, long press to zero

Code	Range	Resolution	Accuracy (20°C)	Measuring force	Output	Power supply	Base
1157-501	0~50mm	1µm/0.00005"	3µm	0.8~1.2N	USB	5V/1A (adapter or charge pal)	granite (flatness: 2µm)
1157-502	0~50mm	1µm/0.00005"	3µm	0.8~1.2N	USB	5V/1A (adapter or charge pal)	ceramic (flatness: 1µm)

OPTIONAL ACCESSORY

Contact point	code 6282
Charge pal	1155-5-POB
Data output cables (including foot switch)	1155-5-FOS

STANDARD DELIVERY

Main unit	1 pc
-----------	------

LARGE RANGE DIGITAL HEIGHT GAGE

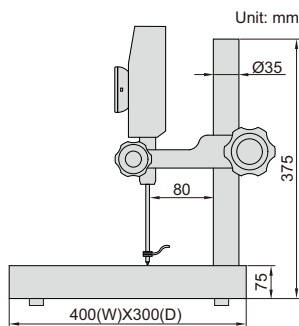

- High stability, high precision, high response speed (5000mm/s)
- High brightness LED display
- Granite base flatness: 3µm

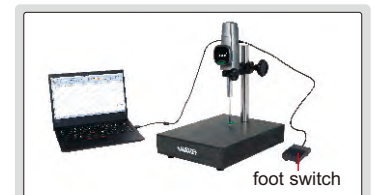
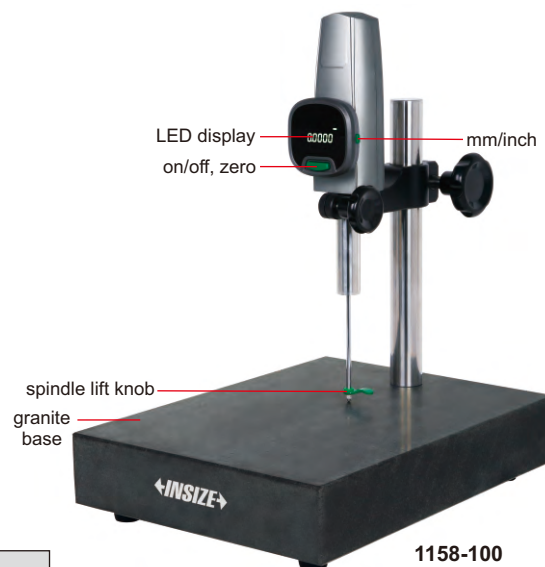

data transmitted to Excel without software; short press the foot switch to transmit data, long press to zero

STANDARD DELIVERY

Main unit	1 pc
-----------	------

OPTIONAL ACCESSORY

Contact point	code 6282
Charge pal	1155-5-POB
Data output cables (including foot switch)	1155-5-FOS

Code	Range	Resolution	Accuracy (20°C)	Measuring force	Output	Power supply
1158-100	0~100mm	0.1µm/0.000005" (can switch to: 1µm/0.00005")	3µm	0.8~1.2N	USB	5V/1A (adapter or charge pal)

DIGITAL HEIGHT GAGES WITH DRIVING WHEEL

DATA
OUTPUT

**INSPECTION
CERTIFICATE**
TRACEABLE TO DKD

4

- Resolution: 0.01mm/0.0005"
- Buttons: on/off, zero, mm/inch, preset +, preset -, ABS/INC
- Automatic power off, move the digital unit to turn on power
- Carbide tipped scriber
- Made of stainless steel
- Battery CR2032
- Data output
- Supplied with dust cover
- With dial test indicator holder
- Optional accessory: data output cable (code 7315-22, 7302-22), clamp for protractors (code 2372-CLAMP)

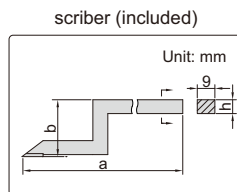
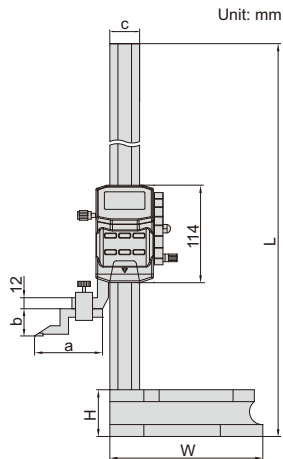

dial test indicator holder (included)

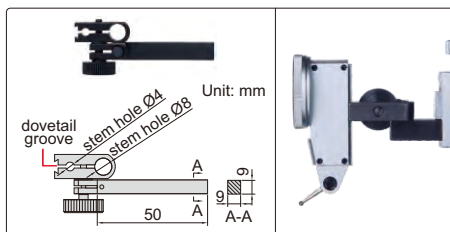

clamp for protractors (optional)

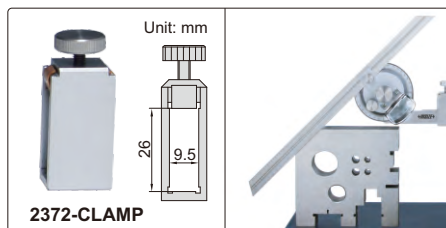

Code	Range	Accuracy	L	W	H	a	b	c	h
1156-300*	0-300mm/0-12"	±0.03mm	515mm	180mm	55mm	80mm	30mm	35mm	9mm
1156-600*	0-600mm/0-24"	±0.05mm	815mm	180mm	55mm	80mm	30mm	35mm	9mm
1156-1000*	0-1000mm/0-40"	±0.07mm	1220mm	265mm	70mm	92mm	48mm	40mm	12mm

*Supplied with manufacturer inspection certificate traceable to DKD Germany

DATA OUTPUT

DIGITAL HEIGHT GAGES

- Resolution: 0.01mm/0.0005"
- Buttons: on/off, zero, mm/inch, ABS/INC, data hold, TOL, set
- ABS/INC is for absolute and incremental measurement
- TOL is for tolerance measurement
- Carbide tipped scriber
- Made of stainless steel (except the base)
- LR44 battery, data output
- Supplied with dial test indicator holder
- Supplied with dust cover (except 1150-1500/2000)
- Optional accessory: wireless transmitter (code 7315-1150), data output cable (code 7302-SPC7, keyboard format), clamp for protractors (code 2372-CLAMP, for 1150-300)

scriber (included)

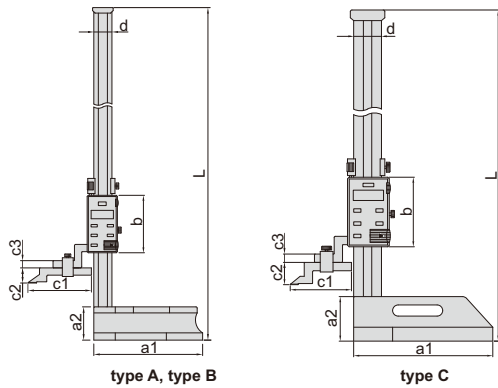
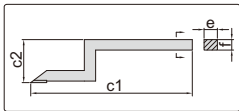

1150-1000

1150-500

1150-300

clamp for protractors (optional) for 1150-300

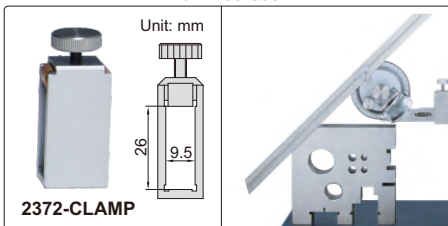

dial test indicator holder (included)

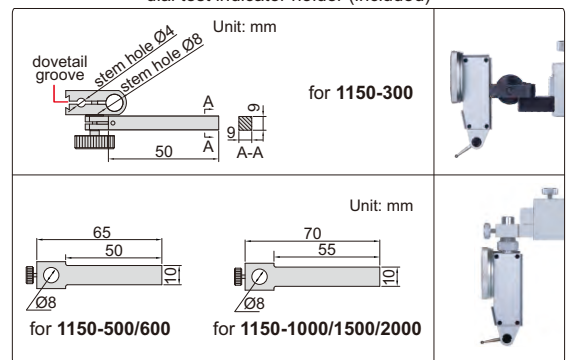

Code	Range	Type	Accuracy	L	a1	a2	b	c1	c2	c3	d	e	f
1150-300	0-300mm/0-12"	A	±0.04mm	485mm	138mm	45mm	95mm	80mm	30mm	10mm	28mm	9mm	9mm
1150-500	0-500mm/0-20"	B	±0.06mm	720mm	180mm	55mm	95mm	103mm	25mm	12mm	30mm	10mm	12mm
1150-600	0-600mm/0-24"	B	±0.06mm	820mm	180mm	55mm	95mm	103mm	25mm	12mm	30mm	10mm	12mm
1150-1000	0-1000mm/0-40"	C	±0.08mm	1275mm	250mm	80mm	125mm	110mm	39mm	15mm	50mm	10mm	15mm
1150-1500	0-1500mm/0-60"	C	±0.12mm	1790mm	280mm	80mm	125mm	110mm	39mm	15mm	50mm	10mm	15mm
1150-2000	0-2000mm/0-80"	C	±0.16mm	2290mm	280mm	80mm	125mm	110mm	39mm	15mm	50mm	10mm	15mm

DIGITAL HEIGHT GAGES

DATA OUTPUT

dial test indicator holder (included)

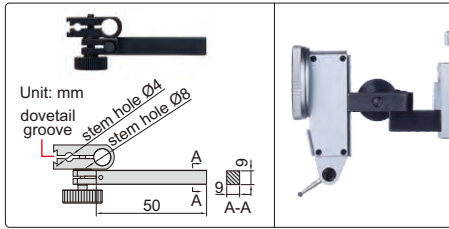

- Resolution: 0.01mm/0.0005"
- Buttons: on/off, zero, mm/inch, data hold, ABS/INC, preset
- ABS/INC is for absolute and incremental measurement
- Automatic power off, move the digital unit to turn on power
- Carbide tipped scriber
- Made of stainless steel
- Battery CR2032, data output
- With driving wheel
- With dial test indicator holder
- Supplied with dust cover
- Optional accessory: clamp for protractors (code **2372-CLAMP**), data output cable (code **7302-1151**, **7315-1151**)



1151-300A

scriber (included)

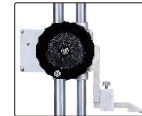
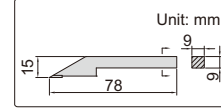

driving wheel on the back

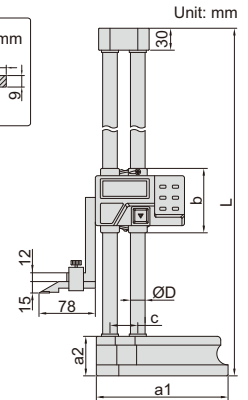

Code	Range	Accuracy	L	a1	a2	b	c	ØD
1151-300A	0-300mm/0-12"	±0.04mm	475	135	43	84	33	15
1151-450A	0-450mm/0-18"	±0.05mm	660	180	54	88	38	20
1151-600A	0-600mm/0-24"	±0.05mm	810	180	54	88	38	20

clamp for protractors (optional)

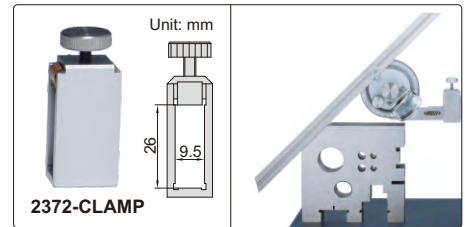

DIAL HEIGHT GAGES

dial test indicator holder (included)

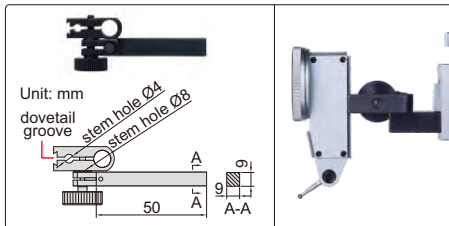

- Dial indicator graduation: 0.01mm
- One counter reads in the plus direction and another in the minus direction, so incremental measurement can be made in either direction
- Carbide tipped scriber
- Made of stainless steel (except the base)
- With driving wheel
- With dial test indicator holder
- Supplied with dust cover
- Optional accessory: clamp for protractors (code **2372-CLAMP**)



1351-300

scriber (included)

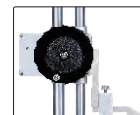
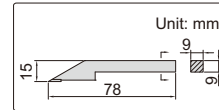

driving wheel on the back

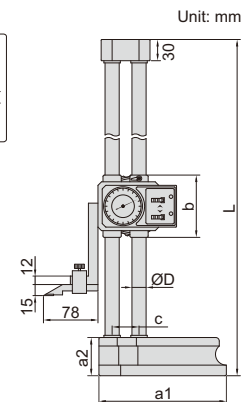

Code	Range	Accuracy	L	a1	a2	b	c	ØD
1351-300	0-300mm	±0.04mm	475	135	43	84	33	15
1351-450	0-450mm	±0.05mm	660	180	54	88	38	20
1351-600	0-600mm	±0.05mm	810	180	54	88	38	20

clamp for protractors (optional)

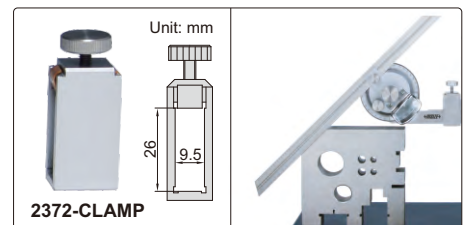

DATA OUTPUT

- Resolution: 0.01mm/0.0005"
- Buttons: on/off, zero, mm/inch
- Automatic power off, move the digital unit to turn on power
- Carbide tipped scriber
- With fine adjustment
- Made of stainless steel
- Battery CR2032
- Optional accessory: dial test indicator holder (code 7151-CL1)

With data interface (data output cable code 7315-22, 7302-22, optional)

Code	Range	Accuracy
1154-150	0-150mm/0-6"	±0.03mm

Built-in wireless (receiver code 7315-2/3/6/7/8 is required)

Code	Range	Accuracy
1154-150WL	0-150mm/0-6"	±0.03mm

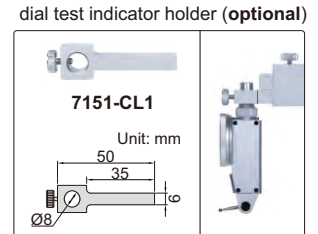
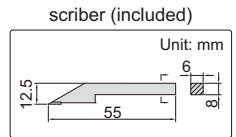
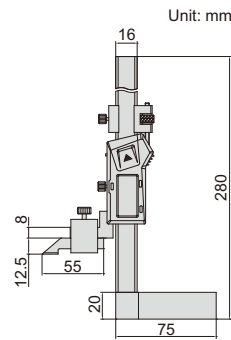

- Graduation: 0.02mm/0.001"
- Adjustable main scale to set zero
- Carbide tipped scriber
- Made of stainless steel (except the base)
- Satin chrome plated scale
- Supplied with magnifier
- With fine adjustment
- Supplied with dust cover
- Optional accessory: dial test indicator holder (code 6293-6), clamp for protractors (code 2372-CLAMP)

dial test indicator holder (optional)

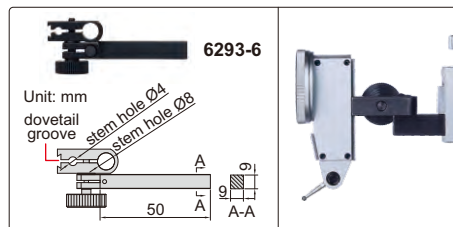

1250-300

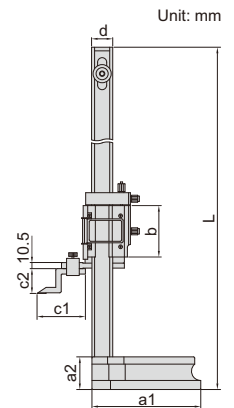
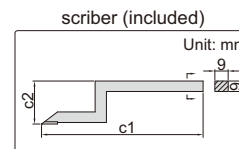

clamp for protractors (optional)

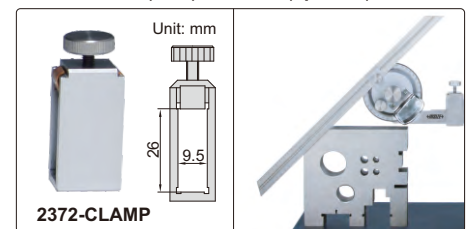

Code	Range	Accuracy	L	a1	a2	b	c1	c2	d
1250-300	0-300mm/0-12"	±0.04mm	545	135	43	75	80	30	28
1250-450	0-450mm/0-18"	±0.05mm	720	180	54	85	80	41	35
1250-600	0-600mm/0-24"	±0.05mm	870	180	54	85	80	41	35

VERNIER HEIGHT GAGES

- Graduation: 0.02mm/0.001"
- Carbide tipped scriber
- Made of stainless steel (except the base)
- Satin chrome plated scale
- Optional accessory: dial test indicator holder (code 7151-CL1)

dial test indicator holder (optional)

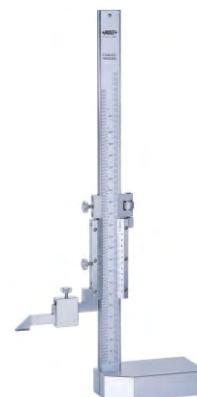
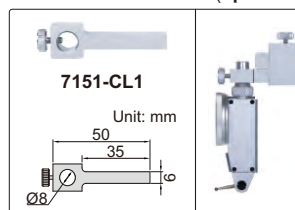

1253-200

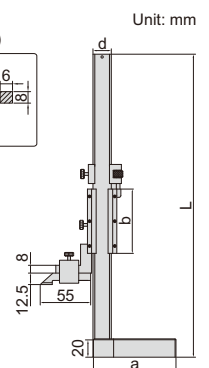
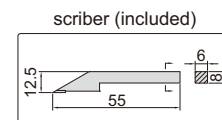

Code	Range	Accuracy	L	a	b	d
1253-150	0-150mm/0-6"	±0.03mm	265	75	57	16
1253-200	0-200mm/0-8"	±0.03mm	325	90	70	20

SCRIBERS FOR HEIGHT GAGES

4

- Carbide tipped



7150-SC1

Code	For height gages	Type	c1	c2	D	E
7150-SC1	1150-300	A	76mm	25mm	6mm	8mm
7150-SC2	1150-500, 1150-600	A	103mm	25mm	10mm	12mm
7150-SC3	1150-1000, 1150-1500, 1150-2000	A	110mm	39mm	10mm	15mm
7150-SC4	1351-300, 1351-450, 1351-600, 1151-300A, 1151-450A, 1151-600A	B	78mm	15mm	9mm	9mm
7150-SC6	1250-300, 1156-300, 1156-600	A	80mm	30mm	9mm	9mm
7150-SC7	1250-450, 1250-600	A	80mm	41mm	9mm	9mm
7150-SC9	1253-150, 1253-200, 1154-150	B	55mm	12.5mm	6mm	8mm
7150-SC10	1156-1000	A	92mm	48mm	9mm	12mm

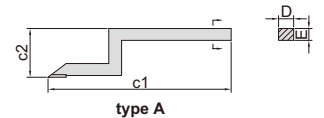

type A

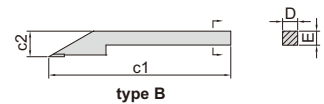

type B

MINI DIGITAL HEIGHT GAGES

DATA OUTPUT

- Measure height difference of two surfaces (1146-20B, 1146-20BWL suitable for surfaces with barrier, such as rivet)
- Resolution: 0.01mm/0.0005"
- Buttons: on/off, zero, mm/inch
- Automatic power off, move the digital unit to turn on power
- Battery CR2032
- Made of stainless steel

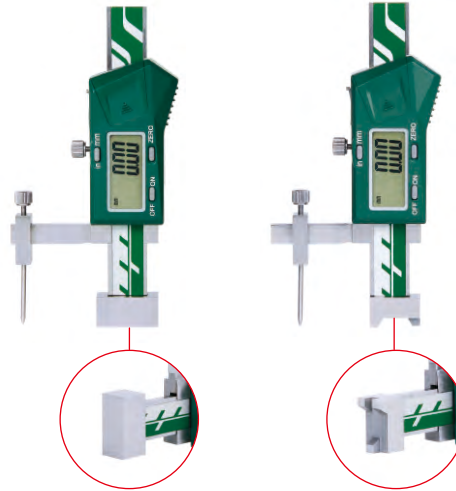

1146-20A

1146-20B

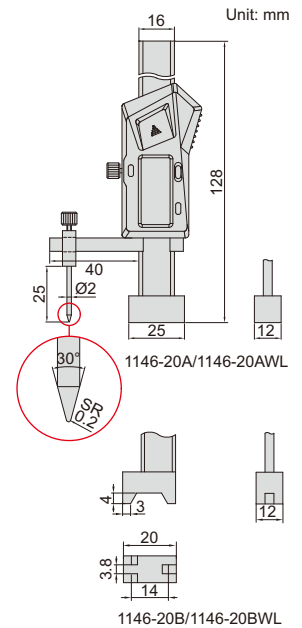

Unit: mm

1146-20B/1146-20BWL

With data interface (data output cable code 7315-21, 7302-21, optional)

Code	Range	Accuracy
1146-20A	0~±20mm/0~±0.8"	±0.02mm
1146-20B	0~±20mm/0~±0.8"	±0.02mm

Built-in wireless (receiver code 7315-2/3/6/7/8 is required)

Code	Range	Accuracy
1146-20AWL	0~±20mm/0~±0.8"	±0.02mm
1146-20BWL	0~±20mm/0~±0.8"	±0.02mm

application of 1146-20A/1146-20AWL

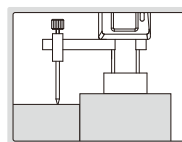

application of 1146-20B/1146-20BWL

